

saheco



## Compact Glass

SV-X70

# COMPACT GLASS



DOWNLOADS LIBRARY |  
BIBLIOTHÈQUE  
TÉLÉCHARGEMENTS

## ES

SV-X70 es un sistema de puerta corredera para paneles de vidrio sin marco que combina las últimas novedades tecnológicas con un atractivo diseño minimalista. El sistema se instala fácil y rápidamente, y es especialmente apropiado para aplicaciones domésticas y comerciales, en las que se integra a la perfección en cualquier diseño.

SV-X70 Oculta todos sus mecanismos dentro del perfil superior consiguiendo un moderno y minimalista aspecto estético.

Este producto permite elegir entre el sistema de frenado con softbrake o un novedoso sistema de frenado anti-shock.

Este sistema se ofrece tanto para montaje a techo como para montaje a pared. Para las instalaciones de montaje a pared, presenta una característica única en que la distancia entre la pared y el panel de vidrio se puede ajustar entre un mínimo de 14mm hasta 25mm, dependiendo de los requisitos de diseño, añadiendo así una mayor versatilidad para los demás beneficios del sistema.

## EN

SV-X70 is a compact sliding solution for frameless glass panels, combining latest technology with an attractive minimalist design. The system is quick and easy to install, and is particularly appropriate for domestic and commercial applications, where it integrates seamlessly into any design.

There is a choice between function and / or an anti-shock braking system.

SV-X70 conceals all of its sliding components within the top track, giving a pleasing aesthetic appearance.

SV-X70 is offered for both ceiling and wall mounted applications; for wall mounted installations, the system offers a unique feature, in that the distance between the wall and the glass panel can be adjusted between a minimal 14mm up to 25mm depending on design requirements, thereby adding a useful versatility to the other benefits of the system.

## FR

SV-X70 est un système de porte coulissante pour panneaux en verre sans cadre qui combine les dernières technologies avec un attrayant-désign minimaliste. Le système a une installation facile et rapide et il est particulièrement adapté pour les applications domestiques et commerciales, et parfaitement bien intègre dans toute conception.

Ce produit vous permet de choisir entre le nouveau système de freinage anti-choc.

SV-X70 il cache tous ses mécanismes dans le profil supérieur avec une esthétique moderne et minimaliste.

Ce système est disponible pour le montage au plafond et pour le montage mural. Pour le montage des installations de mur, il a une caractéristique unique en ce que la distance entre le mur et le panneau de verre peut être réglée entre un minimum de 14mm à 25mm, selon les exigences de la installation, ajoutant ainsi une plus grande polyvalence aux avantages de ce système.





## Características técnicas

Technical characteristics | Caractéristiques techniques

Profiles | Profils

STANDARD



49x60 mm

VIDRIO FIJO  
FIXED GLASS  
VERRE FIXE

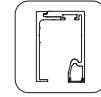

49x70 mm

FRAME

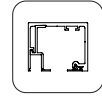

76x61 mm

FT

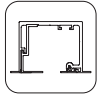

76x61 mm

FT VIDRIO FIJO  
FIXED GLASS  
VERRE FIXE

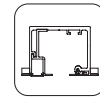

76x61 mm

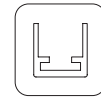

12x12 mm

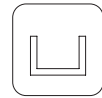

17x12 mm



21x20 mm

Specifications | Spécification

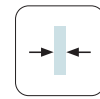

8-10 mm

FRAME



10 mm



**2 Softbrake**  
MÍN. 675mm

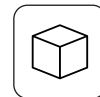

KIT DISPONIBLE  
I AVAILABLE



RODAMIENTO A BOLAS  
BALL BEARING  
ROULEMENT À BILLES



SOFTBRAKE  
MÁX. 70Kg

Weight | Poids

70 kg

166 lb

## Producto certificado

Certificated product | Produit certifié





**Variantes de instalación**

Installation possibilities | Variantes d'installation

**PARED**  
WALL  
MUR

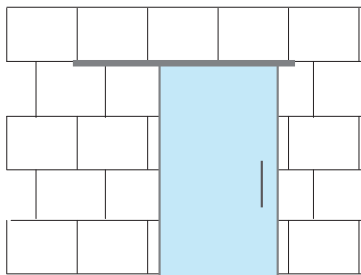

**PARED CON VIDRIO FJO**  
WALL WITH FIXED PANEL  
MUR AVEC VERRE FIXE

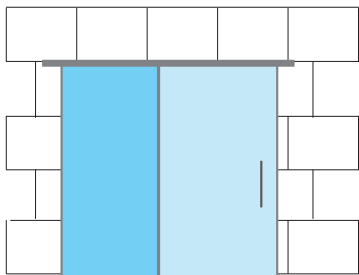

**TECHO**  
CEILING  
PLAFOND

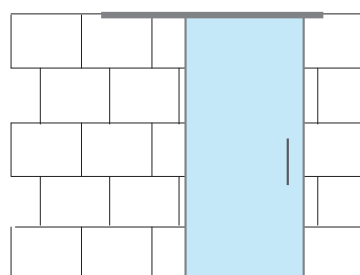

**TECHO CON VIDRIO FJO**  
CEILING WITH FIXED PANEL  
PLAFOND AVEC VERRE FIXE

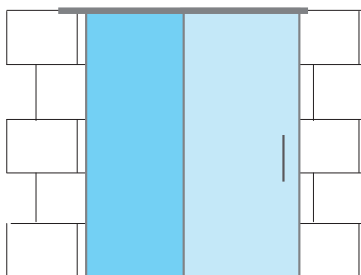

**FALSO TECHO**  
FALSE CEILING  
FAUX PLAFOND

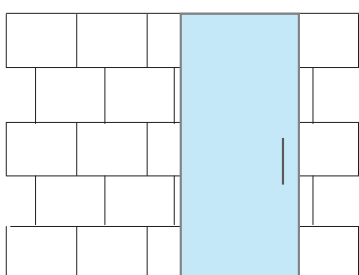

**FALSO TECHO CON VIDRIO FJO**  
FALSE CEILING WITH FIXED PANEL  
FAUX PLAFOND AVEC VERRE FIXE

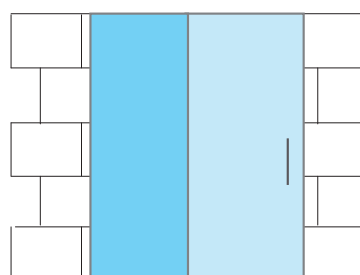

**PARED DE VIDRIO**  
GLASS WALL  
MUR DE VERRE

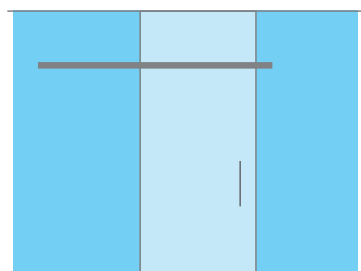

**TECHO CON VIDRIO FJO**  
CEILING WITH FIXED PANEL  
PLAFOND AVEC VERRE FIXE

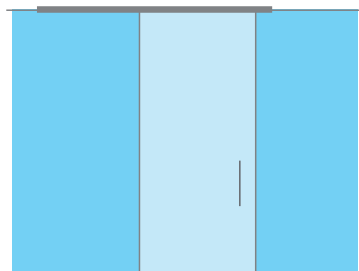

**FALSO TECHO CON VIDRIO FJO**  
FALSE CEILING WITH FIXED PANEL  
FAUX PLAFOND AVEC VERRE FIXE

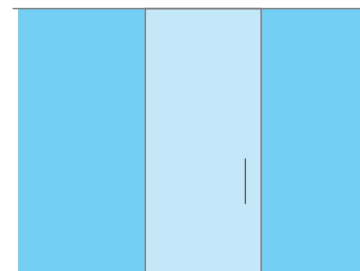

 **PUERTA CORREDERA** | SLIDING DOOR | PORTE COULISSANTE

 **VIDRIO FIJO** | FIXED GLASS | VERRE FIXE



**Sección tipo**

Cross-section | Section type (Cotas en mm | Dimensions in mm | Dimensions en mm)

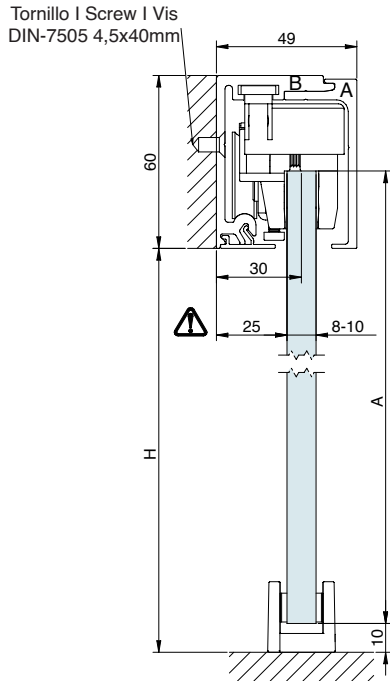

$A = H + 17$

**PARED DE VIDRIO**  
GLASS WALL | MUR DE VERRE

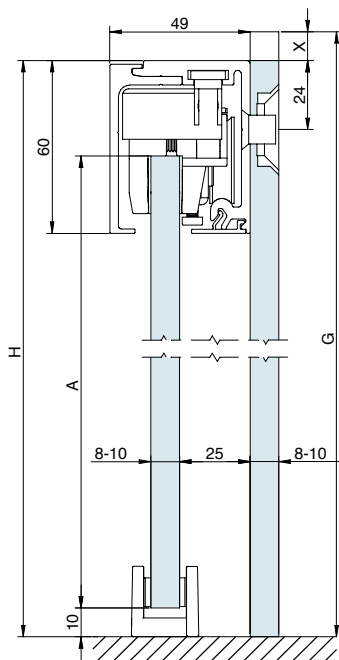

$A = H - 43$

$G = H + X$

**Sección tipo**

Cros-section | Section type (Cotas en mm | Dimensions in mm | Dimensions en mm)

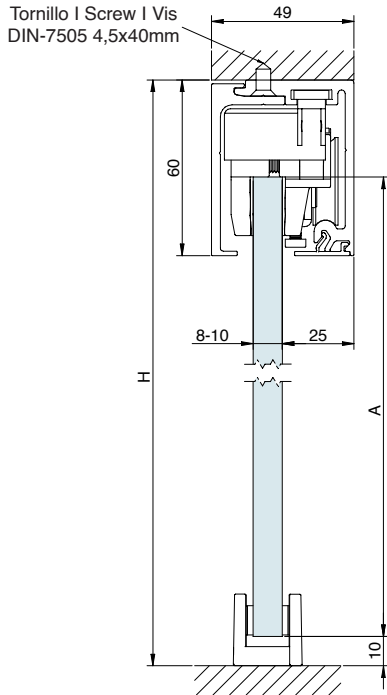

**A= H-43**

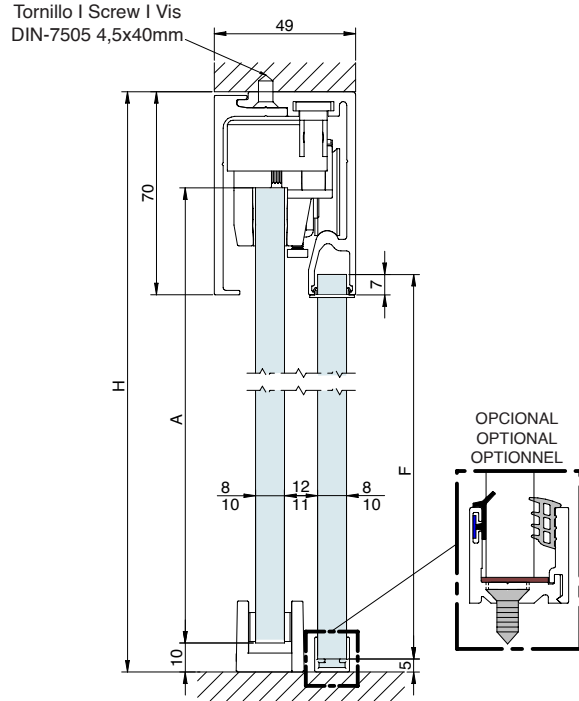

**A= H-43**

**F= H-67**

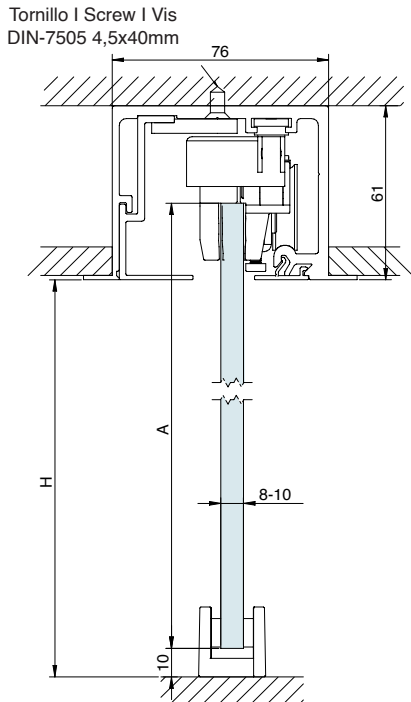

**A= H+17**

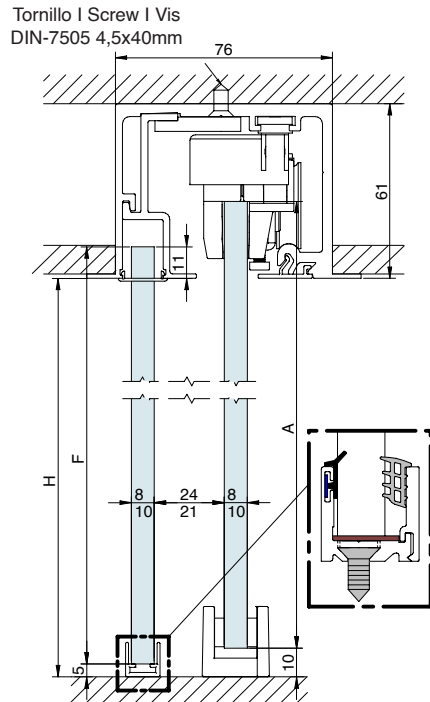

**A= H+17**

**F= H+6**



Componentes

Components | Composants

PERFILERÍA | PROFILES | PROFILS



Conjunto perfil superior corredero  
Sliding top track set  
Jeu rail supérieur coulissant



49x60mm

<b>S</b>	00 70 20	2 m	1 juego 1 set 1 jeu
	00 70 30	3 m	
	00 70 50	5 m	
<b>BS</b>	00 70 22	2 m	
	00 70 32	3 m	
	00 70 52	5 m	
<b>WL</b>	00 71 20	2 m	
	00 71 30	3 m	
	00 71 50	5 m	
<b>BL</b>	00 71 24	2 m	
	00 71 34	3 m	
	00 71 54	5 m	



Conjunto perfil superior corredero para vidrio fijo  
Sliding top track set for fixed glass  
Jeu rail supérieur coulissant pour verre fixe



49x70mm

<b>S</b>	00 70 26	2 m	1 juego 1 set 1 jeu
	00 70 36	3 m	
	00 70 56	5 m	
<b>BS</b>	00 70 28	2 m	
	00 70 38	3 m	
	00 70 58	5 m	
<b>WL</b>	00 71 21	2 m	
	00 71 31	3 m	
	00 71 51	5 m	
<b>BL</b>	00 71 25	2 m	
	00 71 35	3 m	
	00 71 55	5 m	

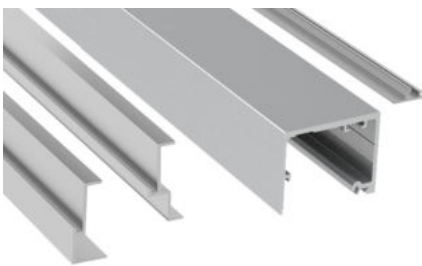

Conjunto perfil superior corredero para accesorio **Frame**  
Sliding top track set for Frame accessory  
Jeu rail supérieur coulissant pour accessoire Frame



76x61mm

<b>S</b>	0 109 86	2 m	1 juego 1 set 1 jeu
	0 109 87	3 m	
	0 109 88	4 m	
	0 109 89	6 m	
<b>WL</b>	0 111 86	2 m	
	0 111 87	3 m	
	0 111 88	4 m	
	0 111 89	6 m	
<b>BL</b>	0 109 94	2 m	
	0 109 95	3 m	
	0 109 96	4 m	
	0 109 97	6 m	

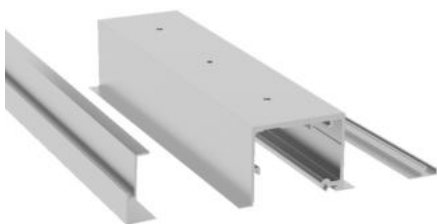

Conjunto perfil superior corredero **FT**.  
Montaje a falso techo.  
FT sliding top track set. False ceiling mounting.  
Set rail supérieur coulissant FT. Fixation à faux plafond.



76x61mm

<b>S</b>	0 109 24	2 m	1 juego 1 set 1 jeu
	0 109 34	3 m	
	0 109 44	4 m	
	0 109 64	6 m	
<b>BS</b>	0 109 25	2 m	
	0 109 35	3 m	
	0 109 45	4 m	
	0 109 65	6 m	
<b>WL</b>	0 119 22	2 m	
	0 119 32	3 m	
	0 119 42	4 m	
	0 119 62	6 m	
<b>BL</b>	0 119 26	2 m	
	0 119 36	3 m	
	0 119 46	4 m	
	0 119 66	6 m	



**Componentes**

Components | Composants

**PERFILERÍA | PROFILES | PROFILS**

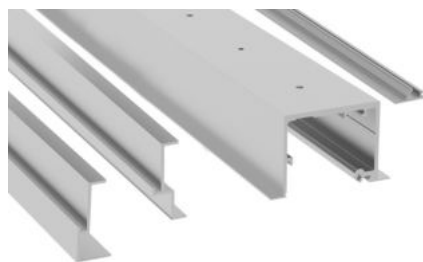

Conjunto perfil superior corredero **FT** para vidrio fijo.  
Montaje a falso techo  
FT sliding top track for fixed glass set. False ceiling mounting  
Set rail supérieur coulissant pour verre fixe.  
Fixation à faux plafond.



76x61mm



0 109 26 2 m  
0 109 36 3 m  
0 109 46 4 m  
0 109 66 6 m



0 109 27 2 m  
0 109 37 3 m  
0 109 47 4 m  
0 109 67 6 m



0 119 23 2 m  
0 119 33 3 m  
0 119 43 4 m  
0 119 63 6 m



0 119 27 2 m  
0 119 37 3 m  
0 119 47 4 m  
0 119 67 6 m

1 juego  
1 set  
1 jeu



Perfil inferior para vidrio fijo de 8-10-12mm  
Bottom track for fixed glass of 8-10-12mm  
Rail inférieur pour verre fixe de 8-10-12mm



17x12mm



00 87 34



00 84 34



00 71 91



00 71 81

3 m

1 perfil  
1 profile  
1 profil

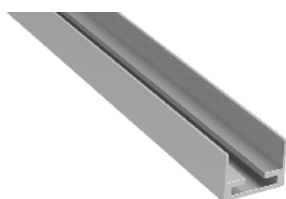

Perfil inferior **Leds**  
Leds bottom track  
Rail inférieur Leds



12x12mm



0 110 30



0 110 31



00 71 92



00 71 82

3 m

1 perfil  
1 profile  
1 profil

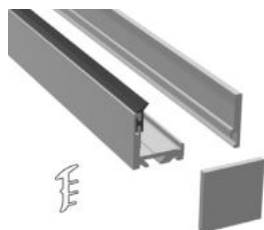

Perfil inferior entrada frontal para vidrio fijo de 8-10-12 mm  
Inferior rail front entry for fixed glass of 8-10-12mm  
Profil inférieur entrée frontale pour verre fixe de 8-10-12mm



21x20mm



0 110 32<sup>1</sup>



0 110 33<sup>1</sup>



0 110 34<sup>1</sup>



0 110 35<sup>1</sup>

3 m

1 perfil  
1 profile  
1 profil

<sup>1</sup>El perfil incluye junta + juegos de tapas laterales | <sup>1</sup>This profile includes PVC joints + set of end caps | <sup>1</sup>Le profil inclue jointes plastiques + capuchons finals

2 m - 2 juegos de tapas | 2 set of caps | 2 set de caupuchons finals 3 m - 4 juegos de tapas | 4 set of caps | 4 set de caupuchons finals 6 m - 6 juegos de tapas | 6 set of caps | 6 set de caupuchons finals

**S** Aluminio anodizado plata mate  
Satin anodized aluminium  
Aluminium anodisé argent

**BS** Aluminio cepillado acabado Inox  
Stainless Steel brushed finish aluminium  
Aluminium brossé finition Inox

**WL** Aluminio lacado blanco mate  
Matt white lacquered aluminium  
Aluminium anodisé laqué blanc mat

**BL** Aluminio lacado negro mate  
Matt black lacquered aluminium  
Aluminium anodisé laqué noir mat





Componentes

Components | Composants

JUEGOS | SETS | JEUX



Juego accesorios **SV-X70** x2 Softbrake  
SV-X70 Fitting set x2 Softbrake  
Garniture SV-X70 x2 Amortisseur

70kg por hoja | per panel | par panneau



RODAMIENTO A BOLAS  
BALL BEARING  
ROULEMENT À BILLES

00 70 01

1 juego  
1 set  
1 jeu



Juego accesorios **SV-X70** x1 Softbrake + x1 freno  
retenedor  
SV-X70 Fitting set x1 Softbrake + x1 Retaining stopper  
Garniture SV-X70 x1 Amortisseur + x1 Frein de retenue

70kg por hoja | per panel | par panneau



RODAMIENTO A BOLAS  
BALL BEARING  
ROULEMENT À BILLES

00 70 03

1 juego  
1 set  
1 jeu



Juego accesorios **SV-X70** x2 Freno retenedor  
SV-X70 Fitting set x2 Retaining stopper  
Garniture SV-X70 x2 Frein de retenue

70kg por hoja | per panel | par panneau



RODAMIENTO A BOLAS  
BALL BEARING  
ROULEMENT À BILLES

00 70 05

1 juego  
1 set  
1 jeu

ACCESORIOS | ACCESSORIES | ACCESSOIRES

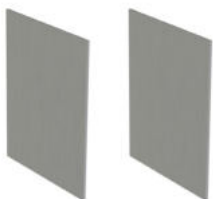

Juego de tapas para perfil superior. Montaje a techo o pared.  
End cover set for top track. Ceiling and wall mounting.  
Jeu de capuchons finals pour rail supérieur. Fixation à mur et à plafond.

S

00 70 70

BS

00 70 72

WL

00 71 93

BL



00 71 83

1 juego  
1 set  
1 jeu

**Componentes**

Components | Composants

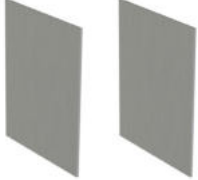
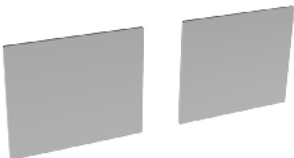
**ACCESORIOS | ACCESSORIES | ACCESSOIRES**

 <p>Juego de tapas para perfil superior con vidrio fijo. Montaje a techo o pared End cover set for top track with fixed glass. Ceiling and wall mounting Jeu de capuchons finals pour profil supérieur avec verre fixe. Fixation à mur et à plafond</p>	<p><b>S</b></p> <p><b>BS</b></p> <p><b>WL</b></p> <p><b>BL</b></p>	<p>00 70 71</p> <p>00 70 73</p> <p>00 71 94</p> <p>00 71 84</p>		<p>1 juego 1 set 1 jeu</p>
 <p>Juego de tapas laterales para perfil superior <b>para accesorio Frame</b>. Montaje a techo Lateral cap set for top track for accessory Frame. Ceiling mounting Jeu de capuchons latéraux pour rail supérieur pour accessoire Frame. Fixation à plafond.</p>	<p><b>S</b></p> <p><b>WL</b></p> <p><b>BL</b></p>	<p>00 70 78</p> <p>00 70 77</p> <p>00 70 79</p>		<p>1 juego 1 set 1 jeu</p>
 <p>Soporte para pared de vidrio Glass wall support Support mur pour installation sur verre</p>		<p>00 70 84<sup>1</sup></p>		<p>10 piezas 10 pieces 10 pièces</p>
 <p>Juego soporte flotante Set of end wall track brackets Jeu supports murales pour rail porteur</p>	<p><b>S</b></p> <p><b>BS</b></p> <p><b>WL</b></p> <p><b>BA</b></p>	<p>00 70 80</p> <p>00 70 81</p> <p>00 71 95</p> <p>00 71 85</p>		<p>1 juego 1 set 1 jeu</p>

<sup>1</sup>El perfil incluye junta + juegos de tapas laterales | <sup>1</sup>This profile includes PVC joints + set of end caps | <sup>1</sup>Le profil inclue jointes plastiques + capuchons finals  
 2 m - 2 juegos de tapas | 2 set of caps | 2 set de caupuchons finals 3 m - 4 juegos de tapas | 4 set of caps | 4 set de caupuchons finals 6 m - 6 juegos de tapas | 6 set of caps | 6 set de caupuchons finals

<p><b>WL</b> Aluminio lacado blanco White lacquered aluminium Aluminium anodisé laqué blanc</p>	<p><b>S</b> Aluminio anodizado plata mate Satin anodized aluminium Aluminium anodisé argent</p>	<p><b>BS</b> Aluminio cepillado acabado Inox Stainless Steel brushed finish aluminium Aluminium brossé finition Inox</p>
<p><b>BL</b> Aluminio lacado negro mate Matt black lacquered aluminium Aluminium anodisé laqué noir mat</p>	<p><b>BA</b> Aluminio anodizado negro Black anodized aluminium Aluminium anodisé noir</p>	



Componentes

Components | Composants

ACCESORIOS | ACCESSORIES | ACCESSOIRES

	<p>Juego soporte flotante (Montaje enrasado) Set of end wall track brackets (Leveled assembly) Jeu supports murales pour rail porteur (Mountage arasé)</p>	<p>GI</p>	<p>00 70 87</p>	<p>1 juego 1 set 1 jeu</p>
	<p>Soporte flotante vidrio Mounting bracket on glass Support de montage sur verre</p> <p>Soporte izquierda Left bracket Support à gauche</p> <p>Soporte derecha Right bracket Support à droite</p>	<p>S BS WL BA S BS WL BA</p>	<p>0 972 02 0 972 03 0 972 07 0 972 08 0 972 05 0 972 06 0 972 09 0 972 10</p>	<p>Izquierda Left À gauche</p> <p>Derecha Right Droite</p> <p>1 unidad 1 unit 1 unité</p>
	<p>Tornillería sujeción 1 metro de perfil Bolts for securing 1 metre of track Vis de fixation 1 mètre de profil</p>	<p>0 160 73</p>	<p>1 juego 1 set 1 jeu</p>	
	<p>Guiador inferior para vidrio de 8-14mm Bottom guide for glass of 8-14mm Guide inférieur pour verre de 8-14mm</p>	<p>S BS WL BL</p>	<p>0 155 73 0 155 79 00 71 90 00 71 80</p>	<p>1 pieza 1 piece 1 pièce</p>

**GI** Hierro cincado  
Galvanized iron  
Fer zingué

**WL** Aluminio lacado blanco mate  
Matt white lacquered aluminium  
Aluminium anodisé laqué blanc mat

**S** Aluminio anodizado plata mate  
Satin anodized aluminium  
Aluminium anodisé argent









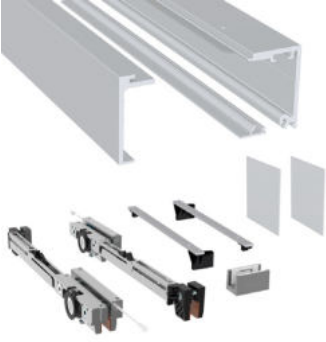

**BA** Aluminio anodizado negro  
Black anodized aluminium  
Aluminium anodisé noir

**BS** Aluminio cepillado acabado inox  
Stainless Steel brushed finish aluminium  
Aluminium brossé finition Inox

**BL** Aluminio lacado negro mate  
Matt black lacquered aluminium  
Aluminium anodisé laqué noir mat

**Componentes**

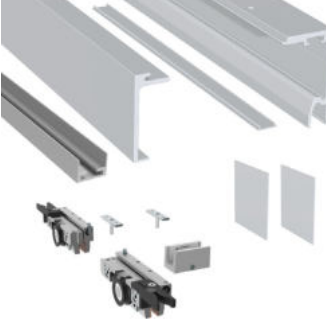
Components | Composants

	<p>Kit <b>SV-X70</b> x2 Softbrake                      SV-X70 kit x2 Softbrake                      Kit SV-X70 x2 Amortisseur</p> <p><b>70kg</b> por hoja   per panel   par panneau</p> <p> 49x60mm</p> <p> RODAMIENTO A BOLAS                      BALL BEARING                      ROULEMENT À BILLES</p>	<p><b>S</b> 0 970 01                      0 970 02</p> <p><b>BS</b> 0 970 05                      0 970 06</p> <p><b>BL</b> 0 970 70                      0 970 71</p>	<p>2 m                      3 m</p> <p>2 m                      3 m</p> <p>2 m                      3 m</p>	<p>1 kit                      1 jeu</p>
	<p>Kit <b>SV-X70</b> x2 Freno retenedor                      SV-X70 kit x2 Retaining stopper                      Kit SV-X70 x2 Freins de retenue</p> <p><b>70kg</b> por hoja   per panel   par panneau</p> <p> 49x60mm</p> <p> RODAMIENTO A BOLAS                      BALL BEARING                      ROULEMENT À BILLES</p>	<p><b>S</b> 0 970 33                      0 970 34</p> <p><b>BS</b> 0 970 37                      0 970 38</p> <p><b>BL</b> 0 970 72                      0 970 73</p>	<p>2 m                      3 m</p> <p>2 m                      3 m</p> <p>2 m                      3 m</p>	<p>1 kit                      1 jeu</p>
	<p>Kit <b>SV-X70</b> para vidrio fijo x2 Softbrake                      SV-X70 kit for fixed glass x2 Softbrake                      Kit SV-X70 pour verre fixe x2 Amortisseur</p> <p><b>70kg</b> por hoja   per panel   par panneau</p> <p> 49x70mm</p> <p> RODAMIENTO A BOLAS                      BALL BEARING                      ROULEMENT À BILLES</p>	<p><b>S</b> 0 970 41                      0 970 42</p> <p><b>BS</b> 0 970 43                      0 970 44</p> <p><b>BL</b> 0 970 74                      0 970 75</p>	<p>2 m                      3 m</p> <p>2 m                      3 m</p> <p>2 m                      3 m</p>	<p>1 kit                      1 jeu</p>
	<p>Kit <b>SV-X70</b> para vidrio fijo x2 Freno retenedor                      SV-X70 kit for fixed glass x2 Retaining stopper                      Kit SV-X70 pour verre fixe x2 Frein de retenue</p> <p><b>70kg</b> por hoja   per panel   par panneau</p> <p> 49x70mm</p> <p> RODAMIENTO A BOLAS                      BALL BEARING                      ROULEMENT À BILLES</p>	<p><b>S</b> 0 970 57                      0 970 58</p> <p><b>BS</b> 0 970 59                      0 970 60</p> <p><b>BL</b> 0 970 76                      0 970 77</p>	<p>2 m                      3 m</p> <p>2 m                      3 m</p> <p>2 m                      3 m</p>	<p>1 kit                      1 jeu</p>



Componentes

Components | Composants

ACCESORIO FRAME | FRAME ACCESSORIE | ACCESSOIRE FRAME  
 Conjunto división interna | Internal division set | Kit de division interne

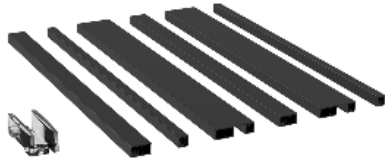

Conjunto marco perimetral para puerta corredera  
 Perimeter frame set for sliding door  
 Kit cadre périmétral pour porte coulissante



10x10mm



19x10mm

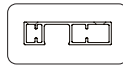

39x10mm

S

0 111 22

WL

0 111 41

BL

0 111 27



1 juego  
1 set  
1 jeu

S

0 111 12

WL

0 111 42

BL

0 111 13



1 juego  
1 set  
1 jeu



Conjunto división interna  
 Internal division set  
 Kit division interne



10x10mm



19x10mm

S

0 111 20

WL

0 111 43

BL

0 111 25

3m

1 juego  
1 set  
1 jeu

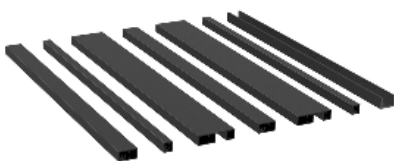

Conjunto marco perimetral para vidrio fijo.  
 Compatible con perfil Frame y perfil FT vidrio fijo.  
 Perimeter frame for fixed glass. Compatible with  
 Frame track and FT fixed glass track.  
 Kit de cadre périmétral pour verre fixe. Compatible  
 avec le rail Frame et le rail FT verre fixe.



17x12mm



10x10mm



19x10mm

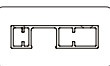

39x10mm

S

0 111 28

WL

0 111 44

BL

0 111 29



1 juego  
1 set  
1 jeu

S

0 111 14

WL

0 111 45

BL

0 111 15



1 juego  
1 set  
1 jeu



Conjunto tiradores Frame  
 Frame handles  
 Poignées Frame

S

0 111 32

WL

0 111 31

BL

0 111 37

1 juego  
1 set  
1 jeu



Aluminio anodizado plata mate  
 Satin anodized aluminium  
 Aluminium anodisé argent



Aluminio lacado blanco mate  
 Matt white lacquered aluminium  
 Aluminium anodisé laqué blanc mat



Aluminio lacado negro mate  
 Matt black lacquered aluminium  
 Aluminium anodisé laqué noir mat





# Compact Glass

SV-X70



Polígono Industrial de Foradada / 08580  
St. Quirze de Besora / Barcelona / Spain  
T +34 93 852 92 23  
F +34 93 852 91 59  
[saheco@saheco.com](mailto:saheco@saheco.com)

Export contact details  
T +34 93 852 96 15  
F +34 93 855 13 42  
[export@saheco.com](mailto:export@saheco.com)